

nVent CADDY Cat HP J-Hook Tree, Flange Mount – CAT64HPSFM2

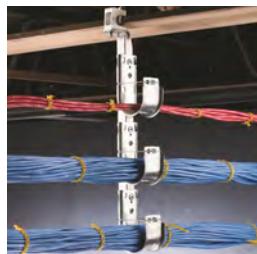

- Easy installation to beam flanges
- Provides optimal support for high-performance data cable, up to and including Cat 5e, Cat 6, Cat 6A, Cat 7 and fibre optic
- Ready to use out of the box, saving installation time and labor
- Requires no screws, rivets or special tools for assembly
- Single- or double-sided tree configurations provide multiple J-Hooks with one structural attachment
- Provides superior fill capacity and load rating over most other non-continuous cable support alternatives
- Complies with EN 50174-2
- Meets ISO®/IEC 14763-2, ANSI®/TIA 568 and ANSI®/TIA 569

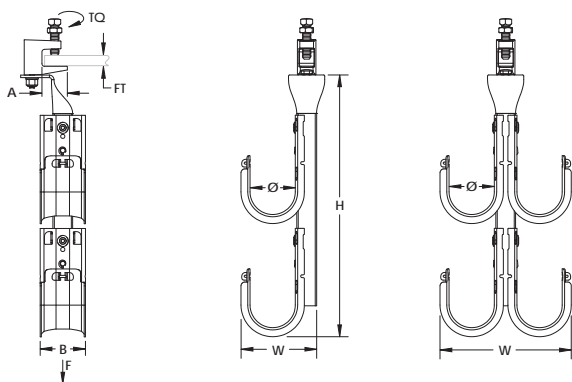

Part Number	CAT64HPSFM2
Material	Steel
Finish	Pregalvanized
Type	Single Sided
Diameter (Ø)	4"
Tiers	2
Flange Thickness (FT)	13/16" Max
Height (H)	15 1/4"
Width (W)	5 7/16"
A	1 1/8"
B	2"
Torque (TQ)	5 ft lb
Static Load (F)	120 lb

Part Number	CAT64HPSFM2
Standard Packaging Quantity	5 pc
UPC	78285680068
EAN-13	8711893137064

Static loads represent maximum load limit of J-Hook tree. Static load limit of each J-Hook is 60 lb (270 N).

Setscrew must be tightened and torqued onto the sloped side of the I-beam.

Non-continuous supports may not exceed spacing of 5' (1.5 m) per TIA 569-C.9.7 and EN 50174-2.

Recognizing that torque wrenches are generally not used or available on many job sites, the setscrew should be tightened so it contacts the I-beam and then an additional 1/4 to 1/2 turn added.

ANSI is a registered trademark of American National Standards Institute. ISO is a registered trademark of International Organization for Standardization.

WARNING

nVent products shall be installed and used only as indicated in nVent's product instruction sheets and training materials. Instruction sheets are available at www.erico.com and from your nVent customer service representative. Improper installation, misuse, misapplication or other failure to completely follow nVent's instructions and warnings may cause product malfunction, property damage, serious bodily injury and death and/or void your warranty.

© 2019 nVent All rights reserved

nVent, nVent CADDY, nVent ERICO, nVent ERIFLEX and nVent LENTON are owned by nVent or its global affiliates.

All other trademarks are the property of their respective owners. nVent reserves the right to change specifications without prior notice.

